

[54] DISPLAY TERMINAL

[75] Inventors: James L. Korzik, Palm Harbor; Thomas Wissman; Richard Anderson, both of Largo; Jorge Suarez, Seminole, all of Fla.

[73] Assignee: Paradyne Corporation, Largo, Fla.

[\*\*] Term: 14 Years

[21] Appl. No.: 292,148

[22] Filed: Aug. 12, 1981

[52] U.S. Cl. .... D14/106

[58] Field of Search ..... D14/100-115; 340/365 R, 700, 711, 720; 364/900

[56] References Cited

U.S. PATENT DOCUMENTS

D. 227,256 6/1973 Conway et al. .... D14/106

OTHER PUBLICATIONS

Datamation, 5/1980, p. 113, NBI, Computer System, Terminal.

Info Systems, 5/1980, p. 53, Raytheon Data Systems, Pts-200 Display (left).

Primary Examiner—Susan J. Lucas  
Attorney, Agent, or Firm—Kane, Dalsimer, Kane, Sullivan & Kurucz

CLAIM

[57] The ornamental design for a display terminal, as shown and described.

DESCRIPTION

FIG. 1 is a front perspective view of a display terminal showing our new design; FIG. 2 is side elevational view thereof; FIG. 3 is a rear view thereof; FIG. 4 is a top plan view thereof; FIG. 5 is a front view thereof on an enlarged scale; and FIG. 6 is a bottom plan view.

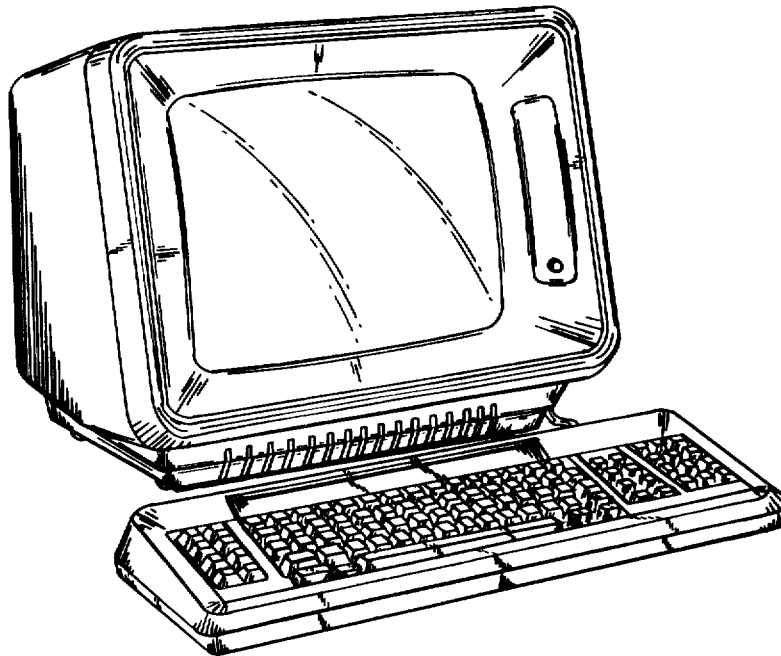

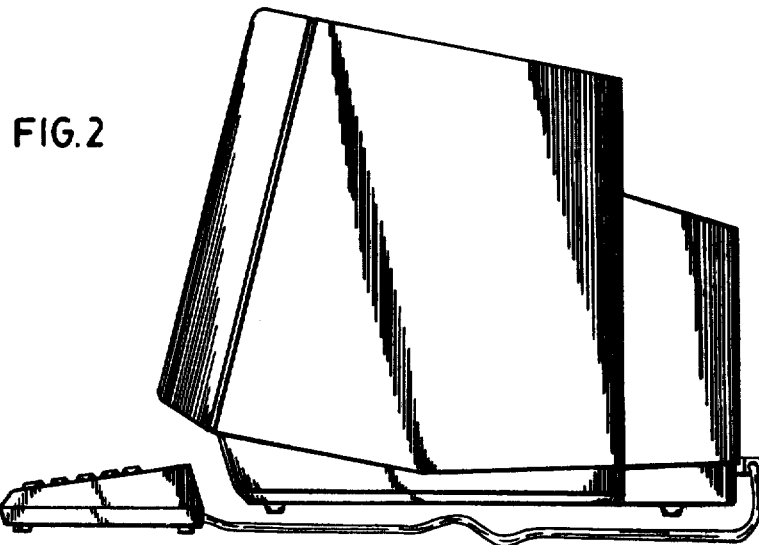
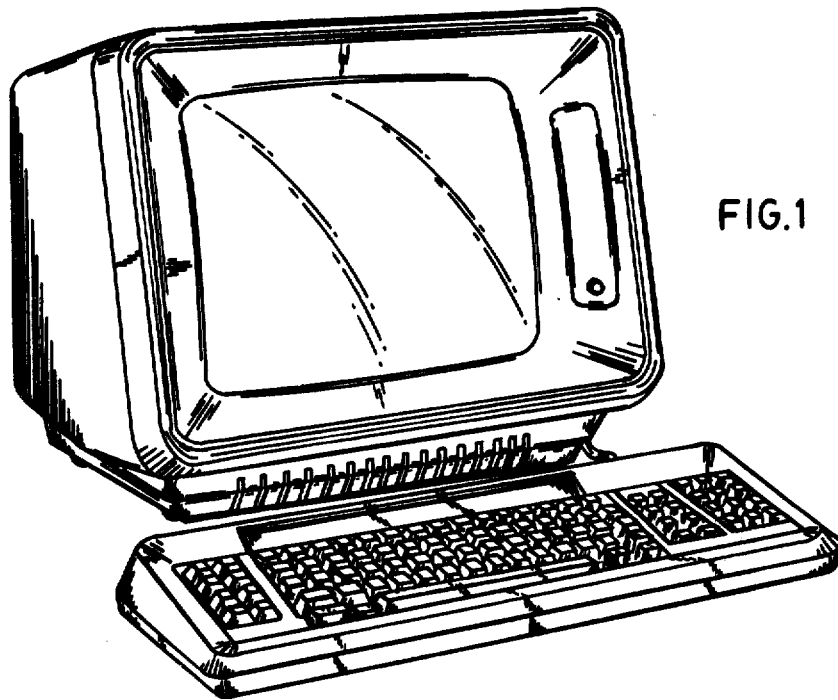

FIG. 3

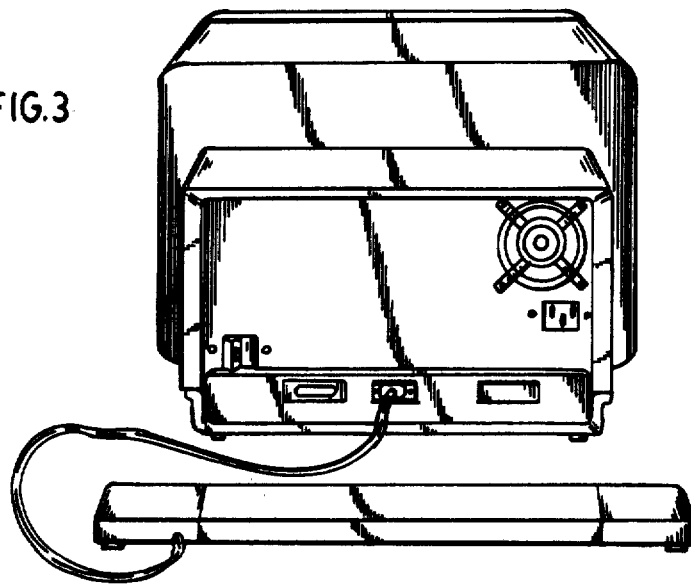

FIG. 4

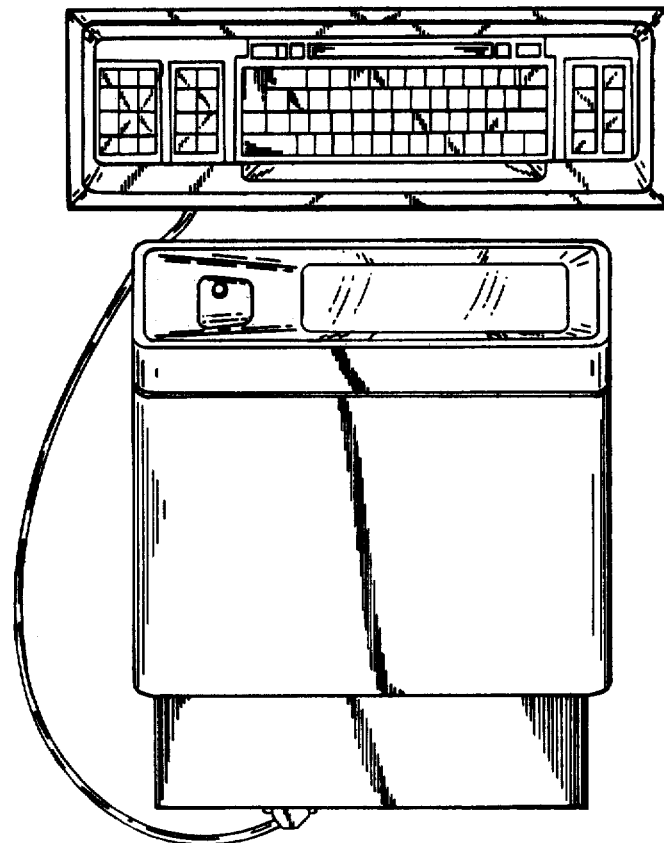

FIG. 5

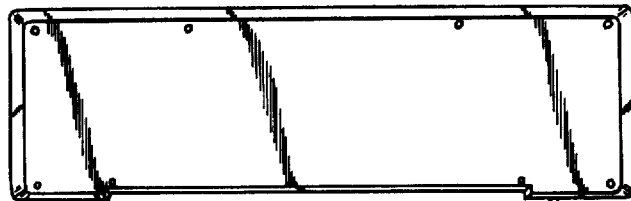
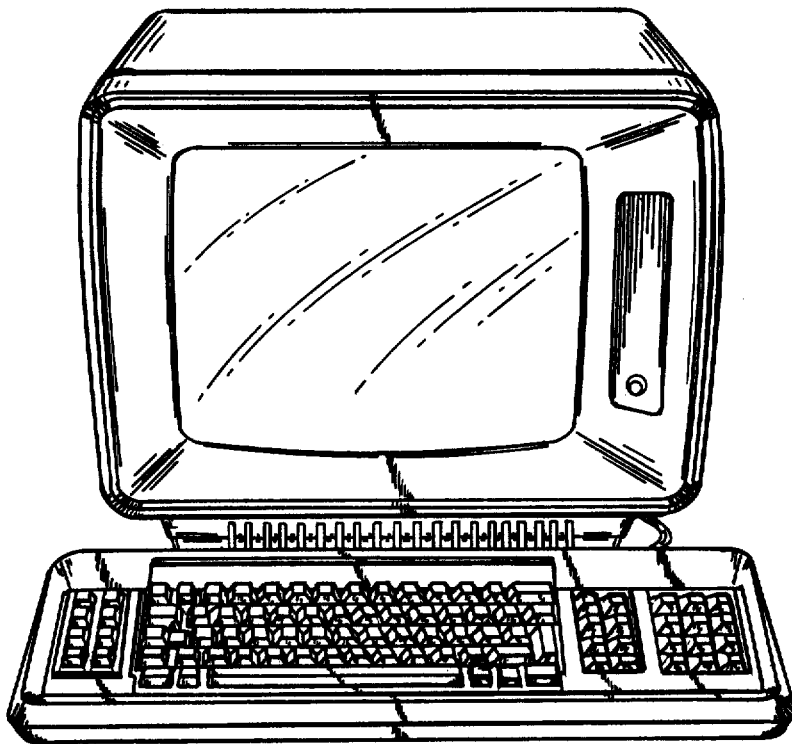

FIG. 6

